



# Assembly Instruction

ITEM NO.:9313GY-RC







RSF CHAISE W / HIDDEN STORAGE



Parts are stored in each unit as show in drawing.  
please take out for assembly.

Note: Do not use power tools for assembly. Power tools increase the risk of over tightening which lead to splitting or cracking the wood.

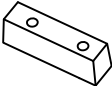
## Component list

No	Drawing	Qty	Description
A		1	RSF CHAISE SEAT
B		1	BACK REST
C		1	BACK CUSHION
D		1	Pillow
E		3	Plastic leg 5-7/8"*2"*2"
F		2	plastic feet 2-1/8"*2"
G		8	Screw 1/5"*2"

### Step 1

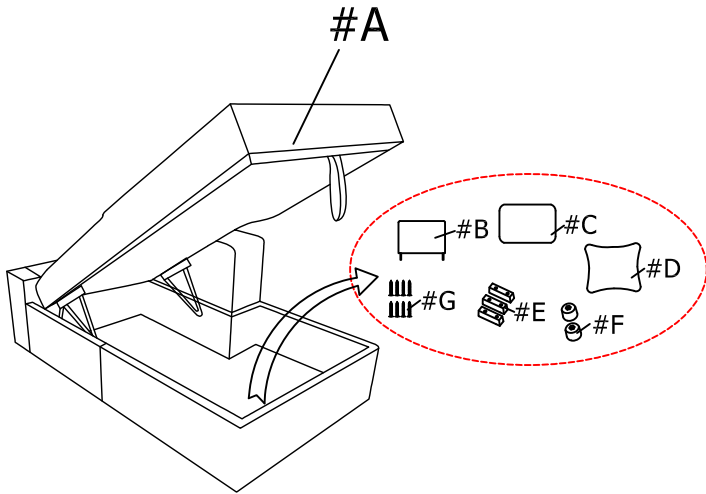

### Step 2

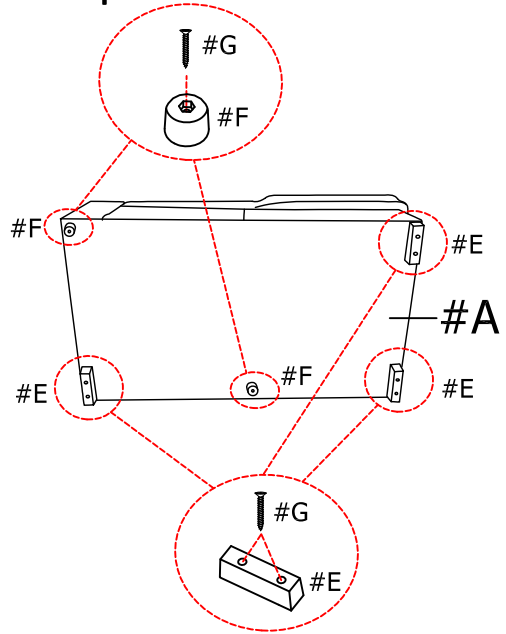

### Step 3

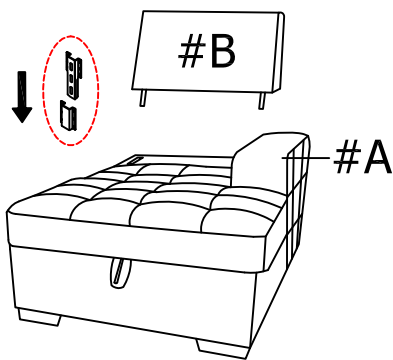

### Step 4

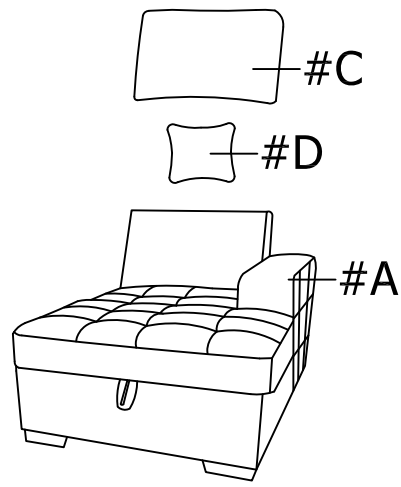

### Step 5

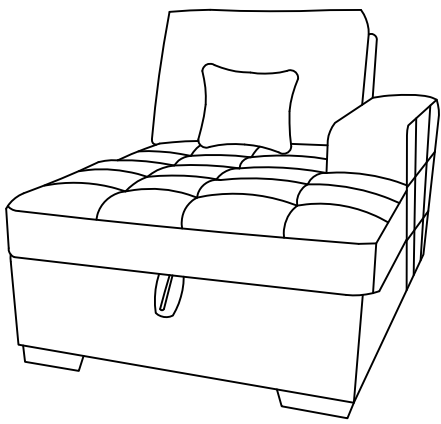

## Step 6

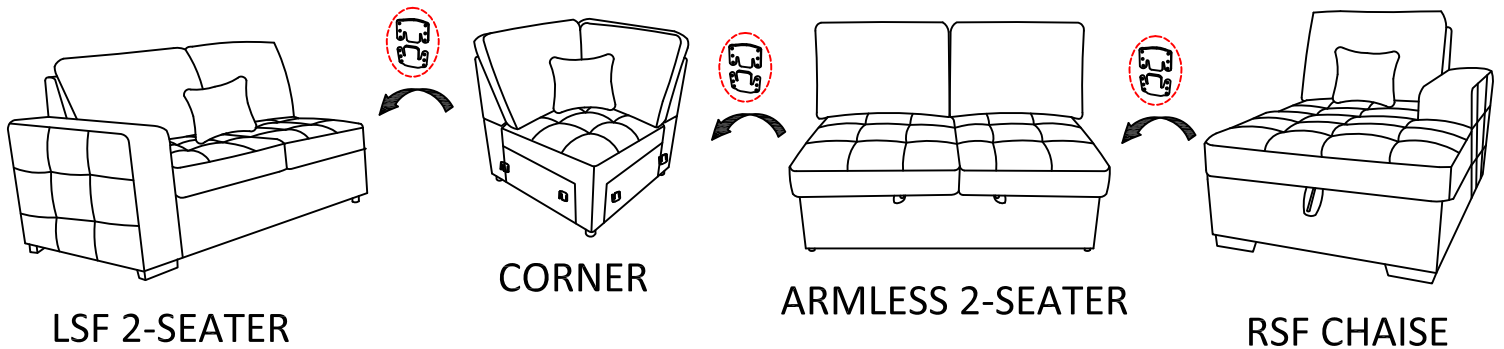

## Step 7

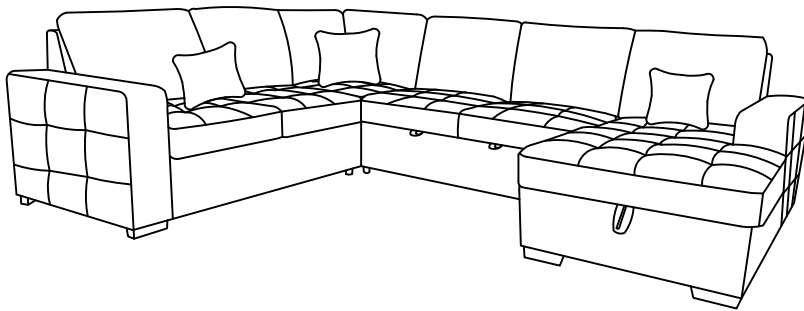

### Care Instruction for Fabric Furniture:

In order to maintain the original appearance of your Fabric Furniture, please follow below simple care procedures:

- Avoid exposing furniture directly to sunlight or heating and air conditioning outlets. Sunlight and or exposure to heating and air conditioning outlets will fade/damage Fabric.
- Vacuum or wipe with a soft cloth to remove dust.



For items use on wooden floor, hard surfaces or carpets, it is recommended to Install protective pads under all legs and supports to avoid/prevent from damages/scratches and discoloration.