

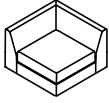





ASSEMBLY INSTRUCTION

ITEM NO: 8435BE-CR/ CORNER SEAT.

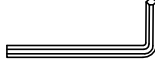
NO.	PARTS LIST	QTY	DESCRIPTION	NO.	PARTS LIST	QTY	DESCRIPTION
A		1	Seat Frame	F		8	Flat Washer M8*Ø19*1.5mm
B		1	Left Back Cushion	G		1	Allen Key M5*100*38mm
C		1	Right Back Cushion	H		1	Geometric pattern pillow 21"*21"
D		4	Wooden Leg 145*145*70mm	I		1	Line pattern pillow 21"*21"
E		8	Allen Bolt ØM8*75				

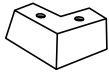
STEP 1:

Location of KD parts
Take out legs from the zippered pocket.

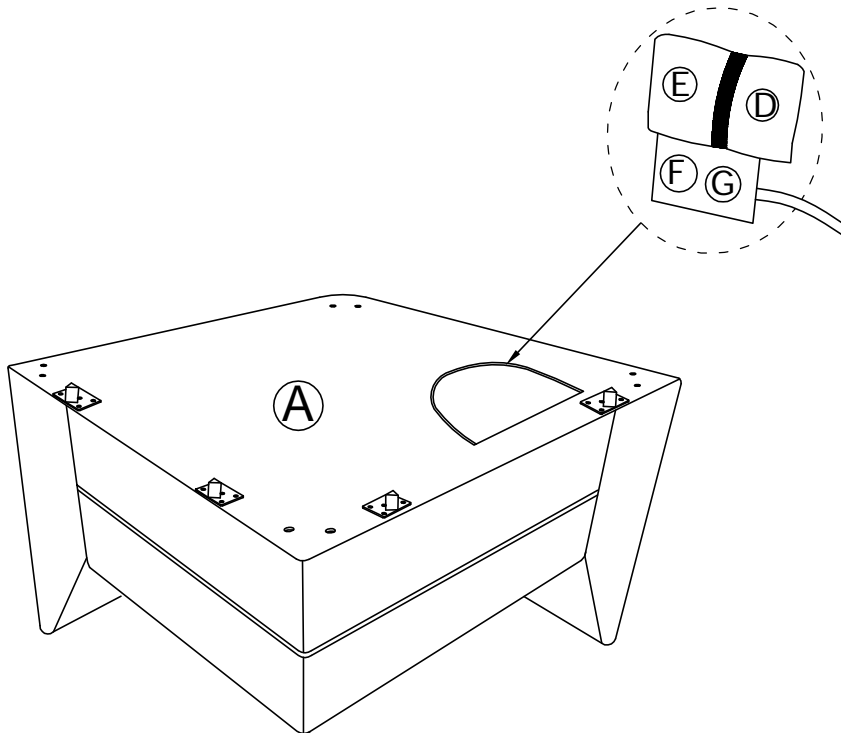

ASSEMBLY INSTRUCTION

ITEM NO: 8435BE-CR/ CORNER SEAT.

STEP 2: Use Allen Bolt (E), Flat Washer (F) and Allen Key (G) to fix Wooden Legs (D) on Seat Frame (A).

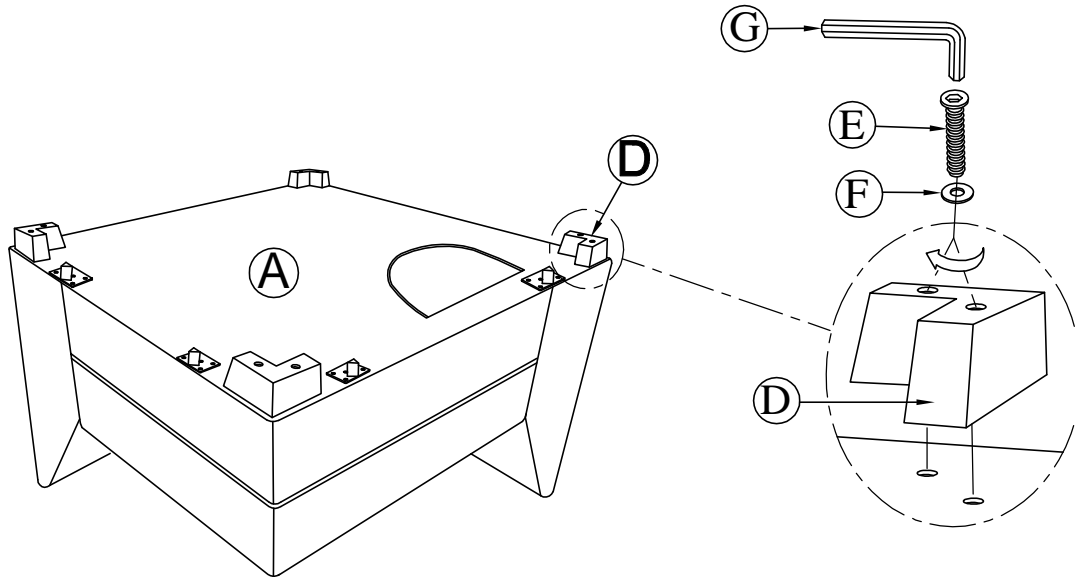

STEP 3: Insert the Left Back Cushions(B), Right Back Cushions(C) and Pillow (H),(I) to Seat Frame(A).

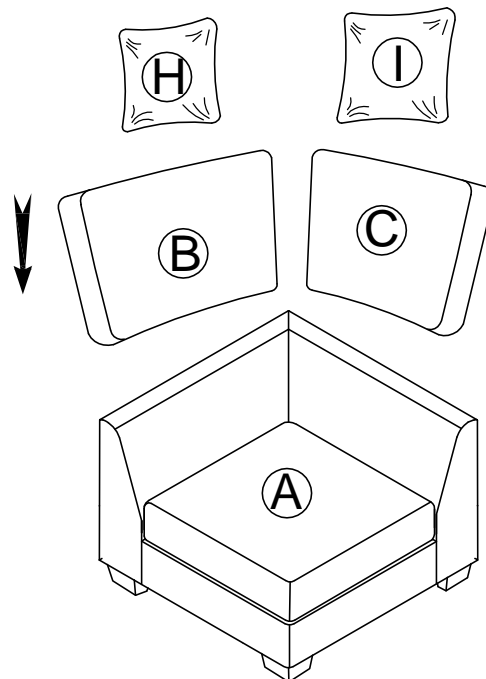

CARE INSTRUCTION FOR FABRIC FURNITURE





In order to maintain the original appearance of your fabric furniture, please follow below simple care procedures.

°Avoid exposing furniture directly to sunlight or heating and air conditioning outlets. Exposure to sunlight or heating and air conditioning outlets will fade/damage fabric.

°Wipe gently with a damp soft cloth to remove dust, dirt and any grime build up.

ASSEMBLY INSTRUCTION

ITEM NO: 8435BE-CR/ CORNER SEAT.

NO.	PARTS LIST	QTY	DESCRIPTION
A		1	CORNER SEAT
B		1	LSF 2-SEATER
C		1	RSF 2-SEATER
D		1	OTTOMAN

STEP 4:

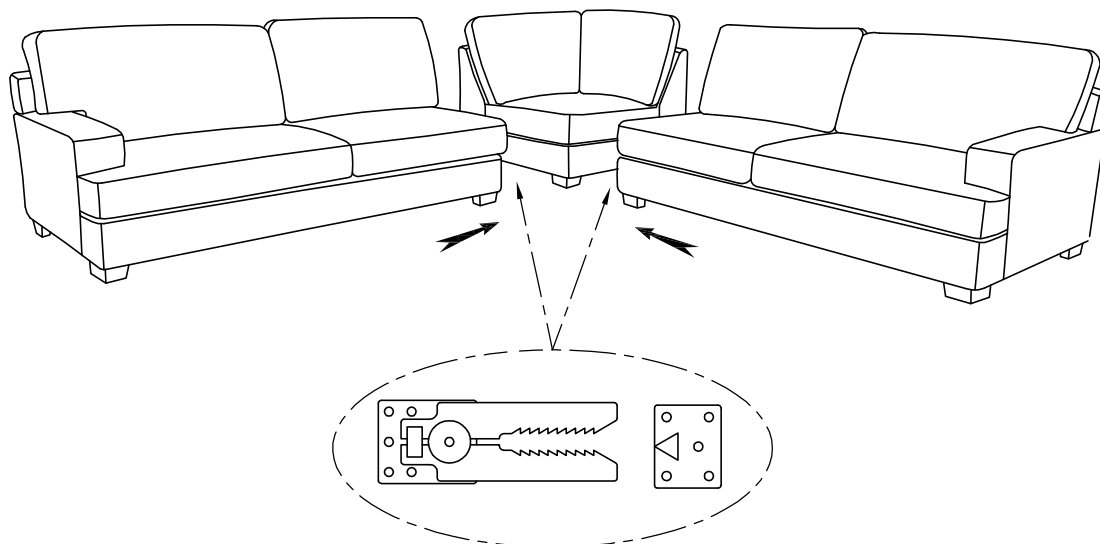

STEP 5:

Completed

